

PROJECT NAME:

24X21- EXTRA HIGH

SIGN IF APPROVED:

DATE APPROVED:

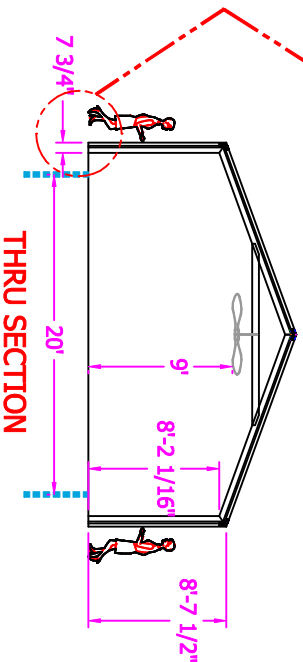
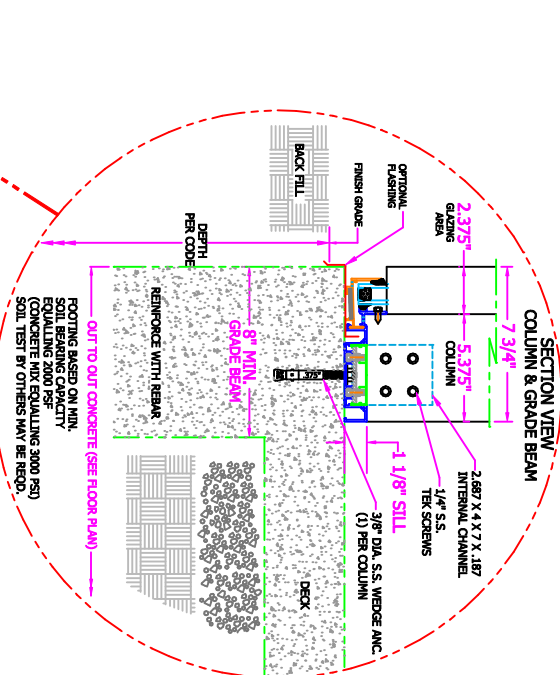
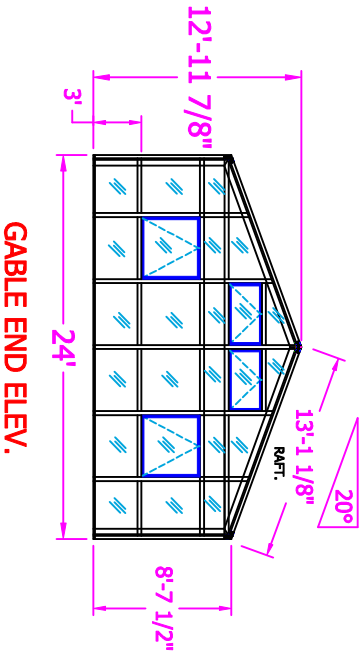
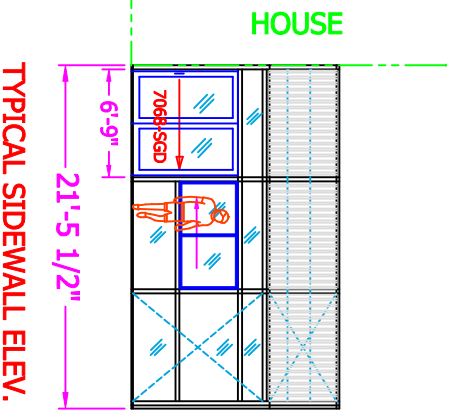
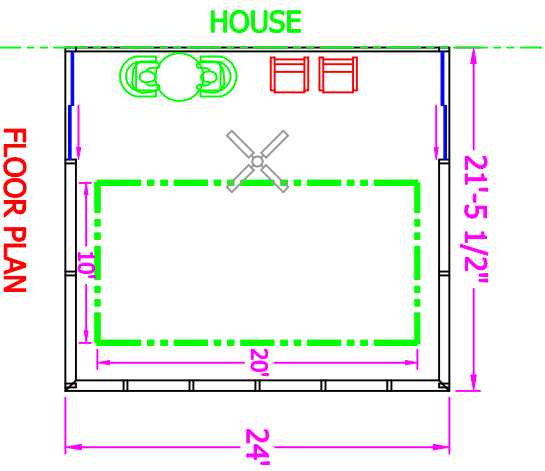
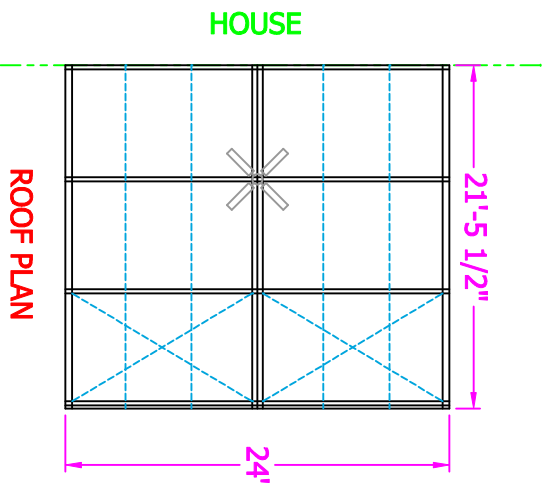

DESIGN LOADS

LIVE - 20 PSF
DEAD - 5 PSF
WIND - 90 MPH
GROUND SNOW LD. =

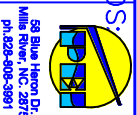

©Copyright 2022 Pool Enclosures, Inc. This drawing is the property of Pool Enclosures, Inc. (P.E.I.) and is not to be reproduced, stored in a retrieval system, or transmitted in any form or by any means, electronic, mechanical, photocopying, recording, or by any information storage and retrieval system, without the prior written authorization of P.E.I. BY ACCEPTING THIS DRAWING THE RECIPIENT AGREES NOT TO REPRODUCE, STORE, TRANSMIT, OR IN ANY MANNER, IN ANY FORM OR BY ANY MEANS, WITHOUT THE WRITTEN AUTHORIZATION OF P.E.I.

BRANN BY	DESCRIPTION
BILL KATERS	POOL ENCLOSURE
SCALE 1/8"=1'-0"	JOB NAME
DATE 12/15/2021	EXAMPLE
SHEET 1	DRAWING NO. 24X21-EH

STD. FRAME COLOR: WHITE OR DARK BRONZE (BAKED ENAMEL / POWDER COAT)