

Trubolt Wedge

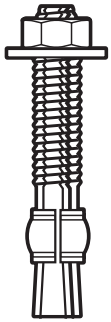

SPECIFIED FOR ANCHORAGE INTO CONCRETE

Trubolt Wedge anchors feature a stainless steel expansion clip, threaded stud body, nut and washer. Anchor bodies are made of plated carbon steel, hot-dipped galvanized carbon steel, type 304 stainless steel or type 316 stainless steel as identified in the drawings or other notations.

The exposed end of the anchor is stamped to identify anchor length. Stampings should be preserved during installation for any subsequent embedment verification.

Use carbide tipped hammer drill bits made in accordance with ANSI B212.15-1994 to install anchors.

Anchors are tested to ACI 355.2 and ICC-ES AC193. Anchors are listed by the following agencies as required by the local building code: ICC-ES, UL, FM, City of Los Angeles, California State Fire Marshal and Caltrans.

See pages 42-43 for performance values in accordance to 2006 IBC.

APPROVALS/LISTINGS

Trubolt® Wedge Anchors

ICC Evaluation Service, Inc. # ESR-2251

- Category 1 performance rating
- 2006 IBC compliant
- Meets ACI 318 ductility requirements
- Tested in accordance with ACI 355.2 and ICC-ES AC193
- For use in seismic zones A & B
- 1/4", 3/8" & 1/2" diameter anchors listed in ESR-2251

Underwriters Laboratories

Factory Mutual

City of Los Angeles - #RR2748

California State Fire Marshall

Caltrans

Meets or exceeds U.S. Government G.S.A. Specification A-A-1923A Type 4 (formerly GSA: FF-S-325 Group II, Type 4, Class 1)

INSTALLATION STEPS

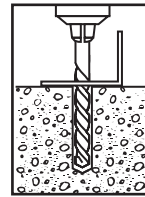

1. Select a carbide drill bit with a diameter equal to the anchor diameter. Drill hole to any depth exceeding the desired embedment. See chart for minimum recommended embedment.

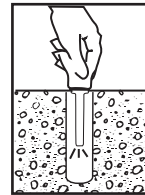

2. Clean hole or continue drilling additional depth to accommodate drill fines.

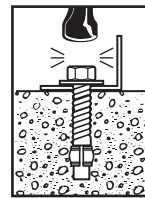

3. Assemble washer and nut, leaving nut flush with end of anchor to protect threads. Drive anchor through material to be fastened until washer is flush to surface of material.

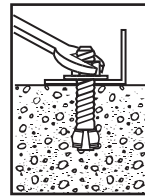

4. Expand anchor by tightening nut 3-5 turns past the hand tight position, or to the specified torque requirement.

**** ONLY FOR USE IN CONCRETE****

LENGTH INDICATION CODE *

CODE	LENGTH OF ANCHOR	CODE	LENGTH OF ANCHOR
A	1-1/2 < 2 (38.1 < 50.8)	K	6-1/2 < 7 (165.1 < 177.8)
B	2 < 2-1/2 (50.8 < 63.5)	L	7 < 7-1/2 (177.8 < 190.5)
C	2-1/2 < 3 (63.5 < 76.2)	M	7-1/2 < 8 (190.5 < 203.2)
D	3 < 3-1/2 (76.2 < 88.9)	N	8 < 8-1/2 (203.2 < 215.9)
E	3-1/2 < 4 (88.9 < 101.6)	O	8-1/2 < 9 (215.9 < 228.6)
F	4 < 4-1/2 (101.6 < 114.3)	P	9 < 9-1/2 (228.6 < 241.3)
G	4-1/2 < 5 (114.3 < 127.0)	Q	9-1/2 < 10 (241.3 < 254.0)
H	5 < 5-1/2 (127.0 < 139.7)	R	10 < 11 (254.0 < 279.4)
I	5-1/2 < 6 (139.7 < 152.4)	S	11 < 12 (279.4 < 304.8)
J	6 < 6-1/2 (152.4 < 165.1)	T	12 < 13 (304.8 < 330.2)

*Located on top of anchor for easy inspection.

PERFORMANCE TABLE

Trubolt		Ultimate Tension and Shear Values (Lbs/kN) in Concrete*							
Wedge Anchors									
ANCHOR DIA. In. (mm)	INSTALLATION TORQUE Ft. Lbs. (Nm)	EMBEDMENT DEPTH In. (mm)	ANCHOR TYPE	f'c = 2000 PSI (13.8 MPa)		f'c = 4000 PSI (27.6 MPa)		f'c = 6000 PSI (41.4 MPa)	
				TENSION Lbs. (kN)	SHEAR Lbs. (kN)	TENSION Lbs. (kN)	SHEAR Lbs. (kN)	TENSION Lbs. (kN)	SHEAR Lbs. (kN)
1/4 (6.4)	4 (5.4)	1-1/8 (28.6)	WS-Carbon or WS-G Hot-Dipped Galvanized or WW-304 S.S. or SWW-316 S.S.	1,180 (5.2)	1,400 (6.2)	1,780 (7.9)	1,400 (6.2)	1,900 (8.5)	1,400 (6.2)
		1-15/16 (49.2)		2,100 (9.3)	1,680 (7.5)	3,300 (14.7)	1,680 (7.5)	3,300 (14.7)	1,680 (7.5)
		2-1/8 (54.0)		2,260 (10.1)	1,680 (7.5)	3,300 (14.7)	1,680 (7.5)	3,300 (14.7)	1,680 (7.5)
3/8 (9.5)	25 (33.9)	1-1/2 (38.1)		1,680 (7.5)	2,320 (10.3)	2,240 (10.0)	2,620 (11.7)	2,840 (12.6)	3,160 (14.1)
		3 (76.2)		3,480 (15.5)	4,000 (17.8)	5,940 (26.4)	4,140 (18.4)	6,120 (27.2)	4,500 (20.0)
		4 (101.6)		4,800 (21.4)	4,000 (17.8)	5,940 (26.4)	4,140 (18.4)	6,120 (27.2)	4,500 (20.0)
1/2 (12.7)	55 (74.6)	2-1/4 (57.2)		4,660 (20.7)	4,760 (21.2)	5,100 (22.7)	4,760 (21.2)	7,040 (31.3)	7,040 (31.3)
		4-1/8 (104.8)		4,660 (20.7)	7,240 (32.2)	9,640 (42.9)	7,240 (32.2)	10,820 (48.1)	8,160 (36.3)
		6 (152.4)		5,340 (23.8)	7,240 (32.2)	9,640 (42.9)	7,240 (32.2)	10,820 (48.1)	8,160 (36.3)
5/8 (15.9)	90 (122.0)	2-3/4 (69.9)		6,580 (29.3)	7,120 (31.7)	7,180 (31.9)	7,120 (31.7)	9,720 (43.2)	9,616 (42.8)
		5-1/8 (130.2)		6,580 (29.3)	9,600 (42.7)	14,920 (66.4)	11,900 (52.9)	16,380 (72.9)	12,520 (55.7)
		7-1/2 (190.5)		7,060 (31.4)	9,600 (42.7)	15,020 (66.8)	11,900 (52.9)	16,380 (72.9)	12,520 (55.7)
3/4 (19.1)	110 (149.2)	3-1/4 (82.6)	7,120 (31.7)	10,120 (45.0)	10,840 (48.2)	13,720 (61.0)	13,300 (59.2)	15,980 (71.1)	
		6-5/8 (168.3)	10,980 (48.8)	20,320 (90.4)	17,700 (78.7)	23,740 (105.6)	20,260 (90.1)	23,740 (105.6)	
		10 (254.0)	10,980 (48.8)	20,320 (90.4)	17,880 (79.5)	23,740 (105.6)	23,580 (104.9)	23,740 (105.6)	
7/8 (22.2)	250 (339.0)	3-3/4 (95.3)	9,520 (42.3)	13,160 (58.5)	14,740 (65.6)	16,580 (73.8)	17,420 (77.5)	19,160 (85.2)	
		6-1/4 (158.8)	14,660 (65.2)	20,880 (92.9)	20,940 (93.1)	28,800 (128.1)	24,360 (108.4)	28,800 (128.1)	
		8 (203.2)	14,660 (65.2)	20,880 (92.9)	20,940 (93.1)	28,800 (128.1)	24,360 (108.4)	28,800 (128.1)	
1 (25.4)	300 (406.7)	4-1/2 (114.3)	13,940 (62.0)	16,080 (71.5)	20,180 (89.8)	22,820 (101.5)	21,180 (94.2)	24,480 (108.9)	
		7-3/8 (187.3)	14,600 (64.9)	28,680 (127.6)	23,980 (106.7)	37,940 (168.8)	33,260 (148.0)	38,080 (169.4)	
		9-1/2 (241.3)	18,700 (83.2)	28,680 (127.6)	26,540 (118.1)	37,940 (168.8)	33,260 (148.0)	38,080 (169.4)	

*Allowable values are based upon a 4 to 1 safety factor. Divide by 4 for allowable load values.

* For Tie-Wire Wedge Anchor, TW-1400, use tension data from 1/4" diameter with 1-1/8" embedment.

*For continuous extreme low temperature applications, use stainless steel.

PERFORMANCE TABLE

Trubolt		Ultimate Tension and Shear Values (Lbs/kN) in Lightweight Concrete*					
Wedge Anchors							
ANCHOR DIA. In. (mm)	INSTALLATION TORQUE Ft. Lbs. (Nm)	EMBEDMENT DEPTH In. (mm)	ANCHOR TYPE	LIGHTWEIGHT CONCRETE f'c = 3000 PSI (20.7 MPa)		LOWER FLUTE OF STEEL DECK WITH LIGHTWEIGHT CONCRETE FILL f'c = 3000 PSI (20.7 MPa)	
				TENSION Lbs. (kN)	SHEAR Lbs. (kN)	TENSION Lbs. (kN)	SHEAR Lbs. (kN)
3/8 (9.5)	25 (33.9)	1-1/2 (38.1)	WS-Carbon or WS-G Hot-Dipped Galvanized or WW-304 S.S. or SWW-316 S.S.	1,175 (5.2)	1,480 (6.6)	1,900 (8.5)	3,160 (14.1)
		3 (76.2)		2,825 (12.6)	2,440 (10.9)	2,840 (12.6)	4,000 (17.8)
1/2 (12.7)	55 (74.6)	2-1/4 (57.2)		2,925 (13.0)	2,855 (12.7)	3,400 (15.1)	5,380 (23.9)
		3 (76.2)		3,470 (15.4)	3,450 (15.3)	4,480 (19.9)	6,620 (29.4)
		4 (101.6)		4,290 (19.1)	3,450 (15.3)	4,800 (21.4)	6,440 (28.6)
5/8 (15.9)	90 (122.0)	3 (76.2)		4,375 (19.5)	4,360 (19.4)	4,720 (21.0)	5,500 (24.5)
		5 (127.0)		6,350 (28.2)	6,335 (28.2)	6,580 (29.3)	9,140 (40.7)
3/4 (19.1)	110 (149.2)	3-1/4 (82.6)		5,390 (24.0)	7,150 (31.8)	5,840 (26.0)	8,880 (39.5)
		5-1/4 (133.4)		7,295 (32.5)	10,750 (47.8)	7,040 (31.3)	N/A

*Allowable values are based upon a 4 to 1 safety factor. Divide by 4 for allowable load values.

PERFORMANCE TABLE

Trubolt Wedge Anchors Recommended Edge and Spacing Distance Requirements for Shear Loads*

ANCHOR DIA. In. (mm)	EMBEDMENT DEPTH In. (mm)	ANCHOR TYPE	EDGE DISTANCE REQUIRED TO OBTAIN MAX. WORKING LOAD In. (mm)	MIN. EDGE DISTANCE AT WHICH THE LOAD FACTOR APPLIED = .60 In. (mm)	MIN. EDGE DISTANCE AT WHICH THE LOAD FACTOR APPLIED = .20 In. (mm)	SPACING REQUIRED TO OBTAIN MAX. WORKING LOAD In. (mm)	MIN. ALLOWABLE SPACING BETWEEN ANCHORS In. (mm) LOAD FACTOR APPLIED = .40
1/4 (6.4)	1-1/8 (28.6)	WS-Carbon or WS-G Hot-Dipped Galvanized or WW-304 S.S. or SWW-316 S.S.	2 (50.8)	1-5/16 (33.3)	N/A	3-15/16 (100.0)	2 (50.8)
	1-15/16 (49.2)		1-15/16 (49.2)	N/A	3-7/8 (98.4)	1-15/16 (49.2)	
3/8 (9.5)	1-1/2 (38.1)		2-5/8 (66.7)	1-3/4 (44.5)	N/A	5-1/4 (133.4)	2-5/8 (66.7)
	3 (76.2)		3-3/4 (95.3)	3 (76.2)	1-1/2 (38.1)	6 (152.4)	3 (76.2)
1/2 (12.7)	2-1/4 (57.2)		3-15/16 (100.0)	2-9/16 (65.1)	N/A	7-7/8 (200.0)	3-15/16 (100.0)
	4-1/8 (104.8)		5-3/16 (131.8)	3-1/8 (79.4)	1-9/16 (39.7)	6-3/16 (157.2)	3-1/8 (79.4)
5/8 (15.9)	2-3/4 (69.9)		4-13/16 (122.2)	3-1/8 (79.4)	N/A	9-5/8 (244.5)	4-13/16 (122.2)
	5-1/8 (130.2)		6-7/16 (163.5)	3-7/8 (98.4)	1-15/16 (49.2)	7-11/16 (195.3)	3-7/8 (98.4)
3/4 (19.1)	3-1/4 (82.6)		5-11/16 (144.5)	3-3/4 (95.3)	N/A	11-3/8 (288.9)	5-11/16 (144.5)
	6-5/8 (168.3)		6-5/16 (160.3)	5 (127.0)	2-1/2 (63.5)	9-15/16 (252.4)	5 (127.0)
7/8 (22.2)	3-3/4 (95.3)		6-9/16 (166.7)	4-5/16 (109.5)	N/A	13-1/8 (333.4)	6-9/16 (166.7)
	6-1/4 (158.8)		8-1/2 (215.9)	6-1/4 (158.8)	3-1/8 (79.4)	12-1/2 (317.5)	6-1/4 (158.8)
1 (25.4)	4-1/4 (108.0)	7-7/8 (200.0)	5-1/8 (130.2)	N/A	15-3/4 (400.1)	7-7/8 (200.0)	
	7-3/8 (187.3)	10-1/16 (255.6)	7-3/8 (187.3)	3-11/16 (93.7)	14-3/4 (374.7)	7-3/8 (187.3)	

*Spacing and edge distances shall be divided by 0.75 when anchors are placed in structural lightweight concrete. Linear interpolation may be used for intermediate spacing and edge distances.

PERFORMANCE TABLE

Trubolt Wedge Anchors Recommended Edge and Spacing Distance Requirements for Tension Loads*

ANCHOR DIA. In. (mm)	EMBEDMENT DEPTH In. (mm)	ANCHOR TYPE	EDGE DISTANCE REQUIRED TO OBTAIN MAX. WORKING LOAD In. (mm)	MIN. ALLOWABLE EDGE DISTANCE AT WHICH THE LOAD FACTOR APPLIED = .65 In. (mm)	SPACING REQUIRED TO OBTAIN MAX. WORKING LOAD In. (mm)	MIN. ALLOWABLE SPACING AT WHICH THE LOAD FACTOR APPLIED = .70 In. (mm)
1/4 (6.4)	1-1/8 (28.6)	WS-Carbon or WS-G Hot-Dipped Galvanized or WW-304 S.S. or SWW-316 S.S.	2 (50.8)	1 (25.4)	3-15/16 (100.0)	2 (50.8)
	1-15/16 (49.2)		1 (25.4)	3-7/8 (98.4)	1-15/16 (49.2)	
	2-1/8 (54.0)		13/16 (20.6)	3-3/16 (81.0)	1-5/8 (41.3)	
3/8 (9.5)	1-1/2 (38.1)		2-5/8 (66.7)	1-5/16 (33.3)	5-1/4 (133.4)	2-5/8 (66.7)
	3 (76.2)		3 (76.2)	1-1/2 (38.1)	6 (152.4)	3 (76.2)
	4 (101.6)		3 (76.2)	1-1/2 (38.1)	6 (152.4)	3 (76.2)
1/2 (12.7)	2-1/4 (57.2)		3-15/16 (100.0)	2 (50.8)	7-7/8 (200.0)	3-15/16 (100.0)
	4-1/8 (104.8)		3-1/8 (79.4)	1-9/16 (39.7)	6-3/16 (157.2)	3-1/8 (79.4)
	6 (152.4)		4-1/2 (114.3)	2-1/4 (57.2)	9 (228.6)	4-1/2 (114.3)
5/8 (15.9)	2-3/4 (69.9)		4-13/16 (122.2)	2-7/16 (61.9)	9-5/8 (244.5)	4-13/16 (122.2)
	5-1/8 (130.2)		3-7/8 (98.4)	1-15/16 (49.2)	7-1/16 (195.3)	3-7/8 (98.4)
	7-1/2 (190.5)		5-5/8 (142.9)	2-13/16 (71.4)	11-1/4 (285.8)	5-5/8 (142.9)
3/4 (19.1)	3-1/4 (82.6)	5-11/16 (144.5)	2-7/8 (73.0)	11-3/8 (288.9)	5-11/16 (144.5)	
	6-5/8 (168.3)	5 (127.0)	2-1/2 (63.5)	9-15/16 (252.4)	5 (127.0)	
	10 (254.0)	7-1/2 (190.5)	3-3/4 (95.3)	15 (381.0)	7-1/2 (190.5)	
7/8 (22.2)	3-3/4 (95.3)	6-9/16 (166.7)	3-5/16 (84.1)	13-1/8 (333.4)	6-9/16 (166.7)	
	6-1/4 (158.8)	6-1/4 (158.8)	3-1/8 (79.4)	12-1/2 (317.5)	6-1/4 (158.8)	
	8 (203.2)	6 (152.4)	3 (76.2)	12 (304.8)	6 (152.4)	
1 (25.4)	4-1/2 (114.3)	7-7/8 (200.0)	3-15/16 (100.0)	15-3/4 (400.1)	7-7/8 (200.0)	
	7-3/8 (187.3)	7-3/8 (187.3)	3-11/16 (93.7)	14-3/4 (374.7)	7-3/8 (187.3)	
	9-1/2 (241.3)	7-1/8 (181.0)	3-9/16 (90.5)	14-1/4 (362.0)	7-1/8 (181.0)	

*Spacing and edge distances shall be divided by 0.75 when anchors are placed in structural lightweight concrete. Linear interpolation may be used for intermediate spacing and edge distances.

Combined Tension and Shear Loading—for Trubolt Anchors

Allowable loads for anchors subjected to combined shear and tension forces are determined by the following equation:

$$(P_s/P_t)^{5/3} + (V_s/V_t)^{5/3} \leq 1$$

P_s = Applied tension load V_s = Applied shear load P_t = Allowable tension load V_t = Allowable shear load

Trubolt Strength Design Performance values in accordance to 2006 IBC

ITW RED HEAD TRUBOLT WEDGE ANCHOR

DESIGN INFORMATION TESTED TO ICC-ES AC193 AND ACI 355.2, IN ACCORDANCE WITH 2006 IBC

Trubolt®
Wedge Anchors

TRUBOLT WEDGE ANCHOR DESIGN INFORMATION^{1,2,3}

DESIGN INFORMATION	Symbol	Units	Nominal Anchor Diameter									
			1/4		3/8		1/2		5/8		3/4	
Anchor O.D.	d_o	in	0.250		0.375		0.500		0.625		0.750	
Effective embedment	h_{ef}	in	1-1/2	2	1-3/4	2-5/8	1-7/8	3-3/8	2-1/2	4	3-1/2	4-3/4
Minimum member thickness	h_{min}	in	4	4	4	5	5	6	5	8	6	8
Critical edge distance	c_{ac}	in	2-5/8	3	2-5/8	5-1/4	3-3/4	6-3/4	5	8	7	9
Minimum edge distance	c_{min}	in	1-3/4	1-1/2	2-1/4	2	3-3/4	3-3/4	4-1/4	3-1/4	3-3/4	3-1/2
Minimum anchor spacing	s_{min}	in	1-3/4	1-1/2	2-1/4	2	3-3/4	3-3/4	4-1/4	3-1/4	3-3/4	3-1/2
Min. Specified Yield Strength	f_y	lb/in ²	55,000									
Min. Specified Ultimate Strength	f_{uta}	lb/in ²	75,000									
Effective tensile stress area	A_{se}	in ²	0.032		0.078		0.142		0.226		0.334	
Steel strength in tension	N_s	lb	2,385		5,815		10,645		16,950		25,050	
Steel strength in shear	V_s	lb	1,430		2,975	3,490	4,450	6,385	6,045	10,170	10,990	15,030
Pullout strength, uncracked concrete	$N_{p,uncr}$	lb	1,392	1,706	2,198	3,469	2,400	4,168	4,155	6,638	8,031	10,561
Anchor Category (All anchors are ductile)			1									
Effectiveness factor k_{uncr} uncracked concrete			24									
Axial stiffness in service load range	β	lb/in	14,651	9,385	17,515	26,424	32,483	26,136	42,899	21,749	43,576	28,697
Coefficient for variation for axial stiffness in service load range			34	47	28	45	17	33	55	22	63	28
Strength reduction factor ϕ for tension, steel failure modes			0.75									
Strength reduction factor ϕ for shear, steel failure modes			0.65									
Strength reduction factor ϕ for tension, concrete failure modes, Condition B			0.65									
Strength reduction factor ϕ for shear, concrete failure modes, Condition B			0.70									

¹ Trubolt+ Anchor Design Strengths must be determined in accordance with ACI 318-05 Appendix D and this table

² The Trubolt+ Wedge Anchor is a ductile steel element as defined by ACI 318 D.1

³ 1/4", 3/8", & 1/2" diameter data is listed in ICC-ES ESR-2251.

Trubolt®
Wedge Anchors

TRUBOLT WEDGE ANCHOR (INSTALLED)

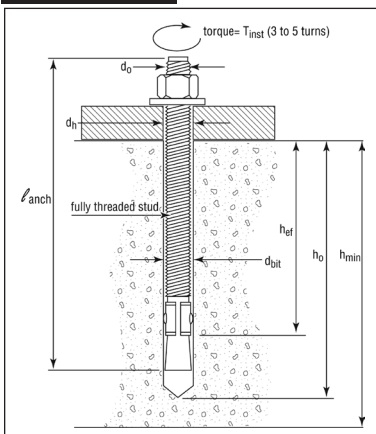

TRUBOLT WEDGE INSTALLATION INFORMATION

	Symbol	Units	Nominal Anchor Diameter (in.)									
			1/4		3/8		1/2		5/8		3/4	
Anchor outer diameter	d_o	in	0.25		0.375		0.5		0.625		0.750	
Nominal carbide bit diameter	d_{bit}	in	1/4		3/8		1/2		5/8		3/4	
Effective embedment depth	h_{ef}	in	1-1/2	2	1-3/4	2-5/8	1-7/8	3-3/8	2-1/2	4	3-1/2	4-3/4
Min hole depth	h_o	in	2	2-1/2	2-1/2	3-3/8	2-3/4	4-1/4	3-3/4	5-1/4	4-3/4	6
Min slab thickness	h_{min}	in	4	4	5	5	6	5	8	6	8	8
Installation torque	T_{inst}	ft-lb	4		25		55		90		110	
Min hole diameter in fixture	d_h	in	5/16		7/16		9/16		11/16		13/16	

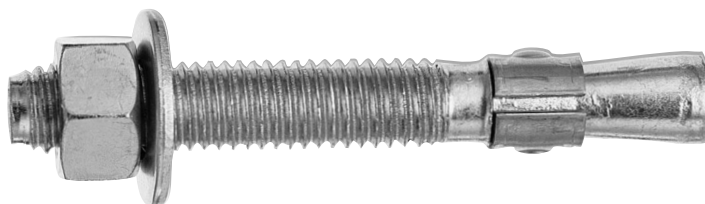

Trubolt Strength Design Performance values in accordance to 2006 IBC

Trubolt®
Wedge Anchors

TRUBOLT WEDGE PULLOUT STRENGTH (N_p, unc) (POUNDS)¹

Nominal Anchor Diameter (in.)	Effective Embedment Depth (in.)	Concrete Compressive Strength			
		$f'c = 2,500$ psi	$f'c = 3,000$ psi	$f'c = 4,000$ psi	$f'c = 6,500$ psi
1/4	1-1/2	1,392	1,525	1,610	1,822
	2	1,706	1,869	1,947	2,151
3/8	1-3/4	2,198	2,408	2,621	3,153
	2-5/8	3,469	3,800	3,936	4,275
1/2	1-7/8	2,400	2,629	3,172	4,520
	3-3/8	4,168	4,520	4,520	4,520
5/8	2-1/2	4,155	4,155	4,376	5,578
	4	6,638	6,900	7,968	10,157
3/4	3-1/2	8,031	8,322	9,610	12,251
	4-3/4	10,561	10,561	10,561	12,251

For SI: 1 inch = 25.4 mm, 1 lbf = 4.45 N, 1 psi = 0.006895 Mpa

¹ Values are for single anchors with no edge distance or spacing reduction.

TRUBOLT WEDGE ANCHOR ALLOWABLE STATIC TENSION (ASD), NORMAL-WEIGHT UNCRACKED CONCRETE¹⁻⁶

Nominal Anchor Diameter (in.)	Effective Embedment Depth (in.)	Concrete Compressive Strength			
		$f'c = 2,500$ psi	$f'c = 3,000$ psi	$f'c = 4,000$ psi	$f'c = 6,500$ psi
1/4	1-1/2	611	670	707	800
	2	749	821	855	945
3/8	1-3/4	965	1,058	1,151	1,385
	2-5/8	1,524	1,669	1,729	1,878
1/2	1-7/8	1,054	1,155	1,393	1,985
	3-3/8	1,831	1,985	1,985	1,985
5/8	2-1/2	1,825	1,825	1,922	2,450
	4	2,915	3,030	3,499	4,461
3/4	3-1/2	3,527	3,655	4,221	5,381
	4-3/4	4,638	4,638	4,638	5,381

For SI: 1 inch = 25.4 mm, 1 lbf = 4.45 N, 1 psi = 0.006895 Mpa

Design Assumptions:

- ¹ Single anchor with static tension load only.
- ² Concrete determined to remain uncracked for the life of the anchorage.
- ³ Load combinations from 2006 IBC, Sections 1605.2.1 and 1605.3.1 (no seismic loading).
- ⁴ Thirty percent dead load and 70 percent live load, controlling load combination 1.2D + 1.6L
- ⁵ Calculation of weighted average: 1.2D + 1.6L = 1.2 (0.3) + 1.6 (0.7) = 1.48
- ⁶ Values do not include edge distance or spacing reductions.



TRUBOLT WEDGE ANCHOR ALLOWABLE STATIC SHEAR (ASD), STEEL (POUNDS)¹⁻⁵

Nominal Anchor Diameter (in.)	Effective Embedment Depth (in.)	Allowable Steel Capacity, Static Shear
1/4	1-1/2	628
	2	
3/8	1-3/4	1,307
	2-5/8	1,533
1/2	1-7/8	1,954
	3-3/8	2,804
5/8	2-1/2	2,655
	4	4,467
3/4	3-1/2	4,827
	4-3/4	6,601

For SI: 1 inch = 25.4 mm, 1 lbf = 4.45 N, 1 psi = 0.006895 Mpa

Design Assumptions:

- ¹ Single anchor with static shear load only.
- ³ Load combinations from 2006 IBC, Sections 1605.2.1 and 1605.3.1 (no seismic loading).
- ³ Thirty percent dead load and 70 percent live load, controlling load combination 1.2D + 1.6L
- ⁴ Calculation of weighted average: 1.2D + 1.6L = 1.2 (0.3) + 1.6 (0.7) = 1.48
- ⁵ Values do not include edge distance or spacing reductions.